

IKA

designed for scientists

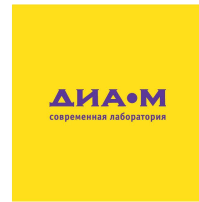

EN

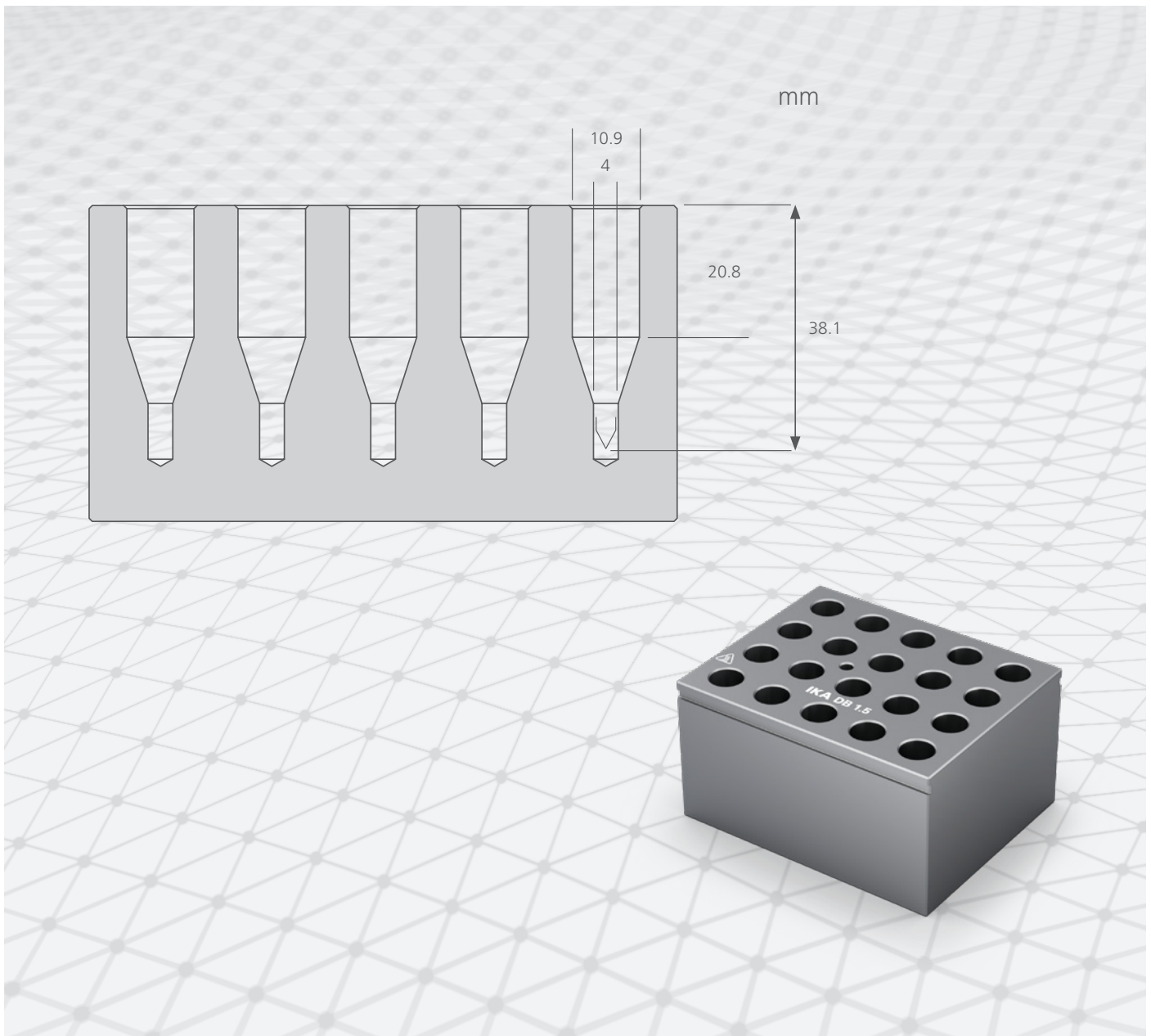

Overview | Heating block geometries

Heating blocks

DB 1



DB 1.1 | 3

DB 2



DB 2.1 | 8

DB 3



DB 3.1 | 10

DB 4



DB 4.1 | 13

DB 5



DB 5.1 | 22

DB 6



DB 6.1 | 31



DB 1.2 | 4



DB 2.2 | 9



DB 3.2 | 11



DB 4.2 | 14



DB 5.2 | 23



DB 6.2 | 32



DB 1.3 | 5



DB 3.3 | 12



DB 4.3 | 15



DB 5.3 | 24

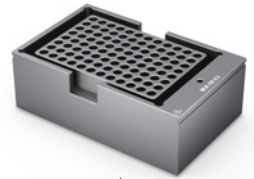

DB 6.3 | 33



DB 1.4 | 6



DB 4.4 | 16



DB 5.4 | 25



DB 1.5 | 7



DB 4.5 | 17



DB 5.5 | 26



DB 4.6 | 18



DB 5.6 | 27



DB 4.7 | 19



DB 5.7 | 28



DB 4.8 | 20



DB 5.8 | 29



DB 4.9 | 21



DB 5.9 | 30

DB 7



DB 7.1 | 34

DB 8



DB 8.1 | 35

Heating Block DB 1.1



Heating Block DB 1.2



Heating Block DB 1.3



Heating Block DB 1.4



mm

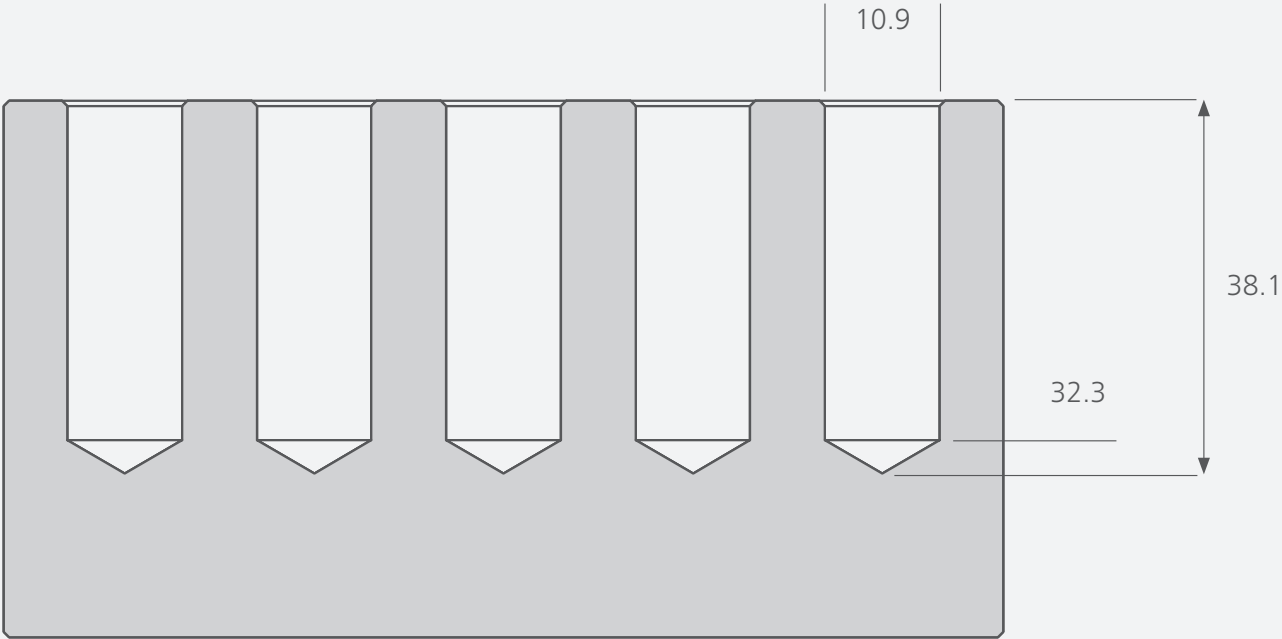

Heating Block DB 1.5

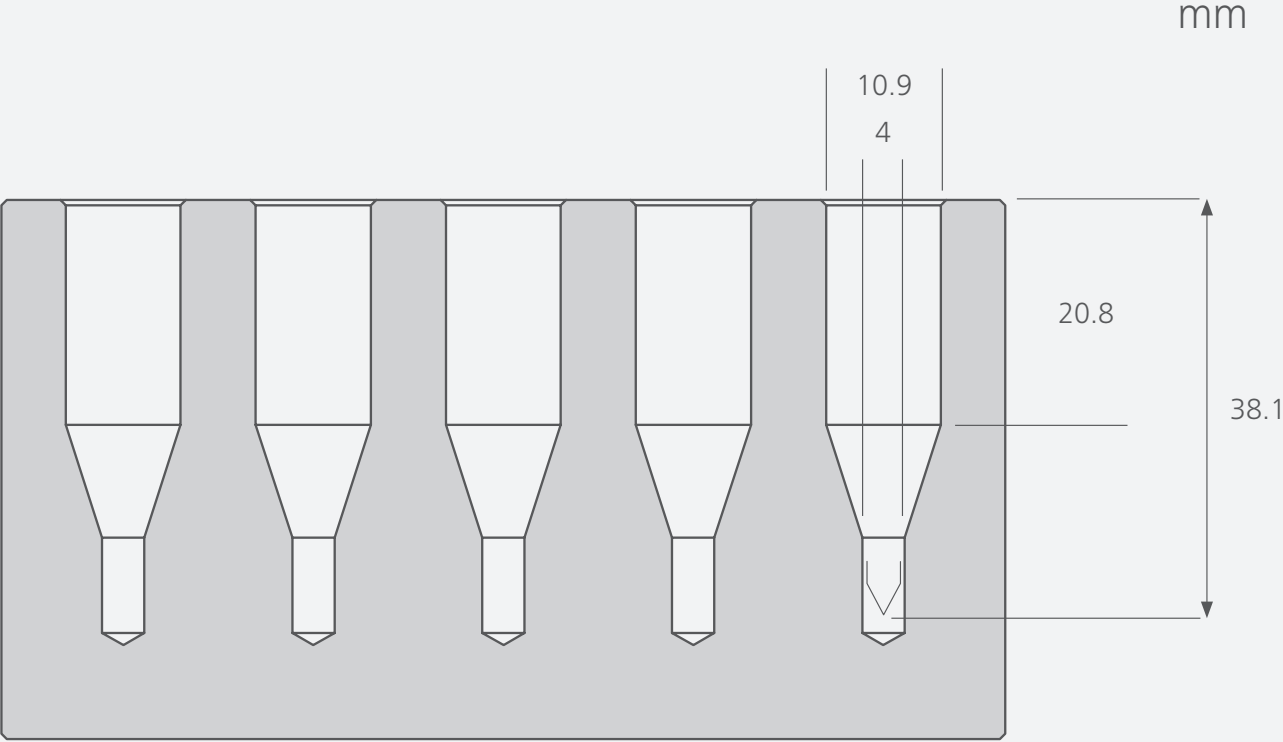

Heating Block DB 2.1



Heating Block DB 2.2



mm

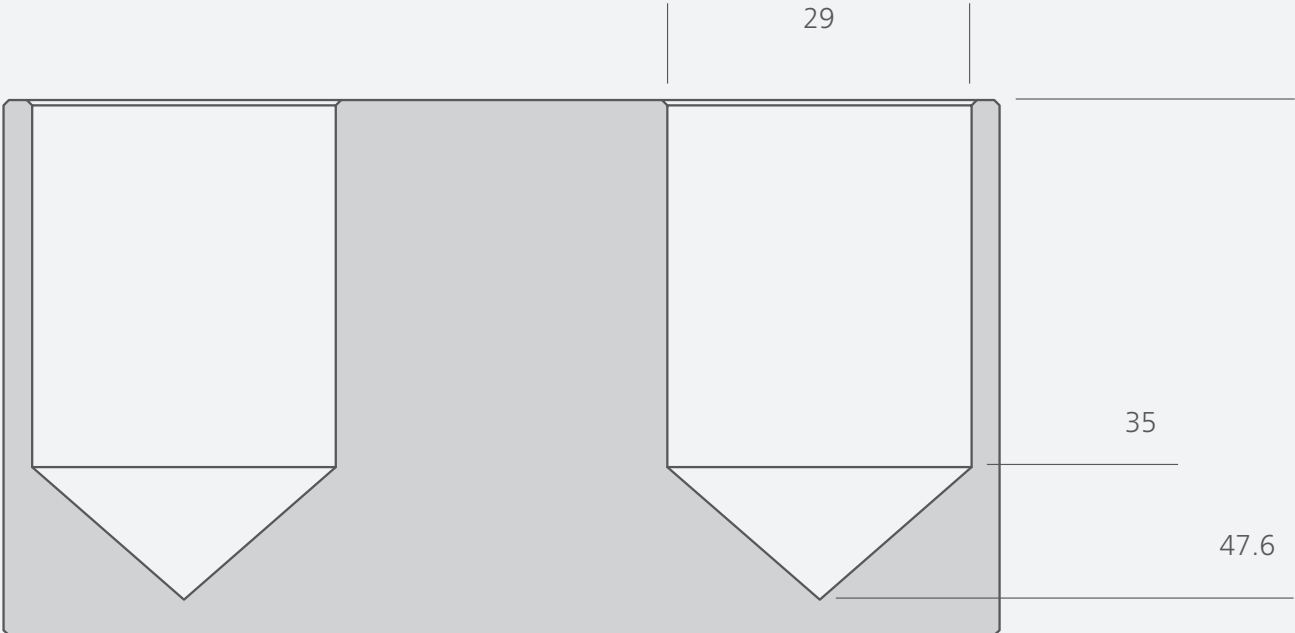

Heating Block DB 3.1



A-A (1:1)



B-B (1:1)



C-C (1:1)

Heating Block DB 3.2

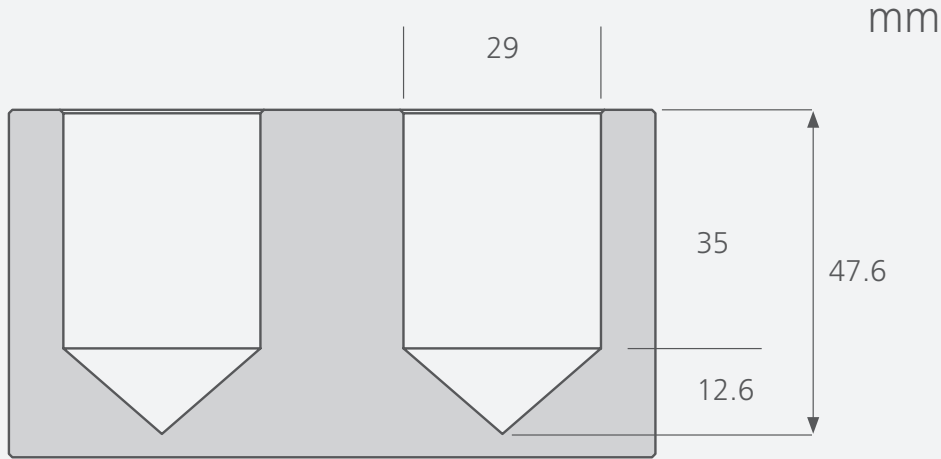

A-A (1:1)

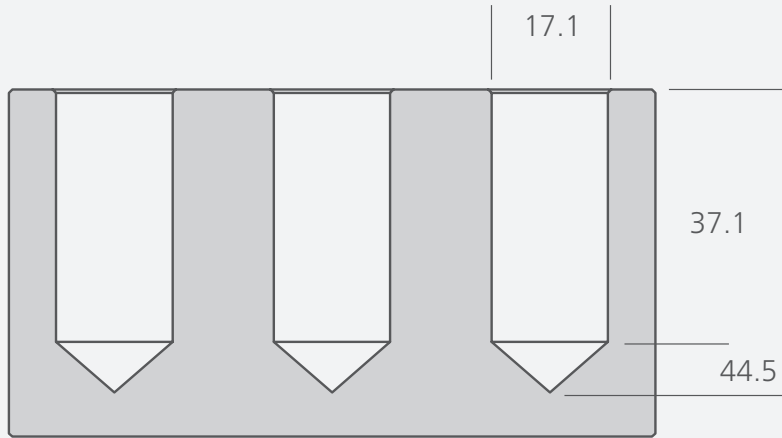

B-B (1:1)

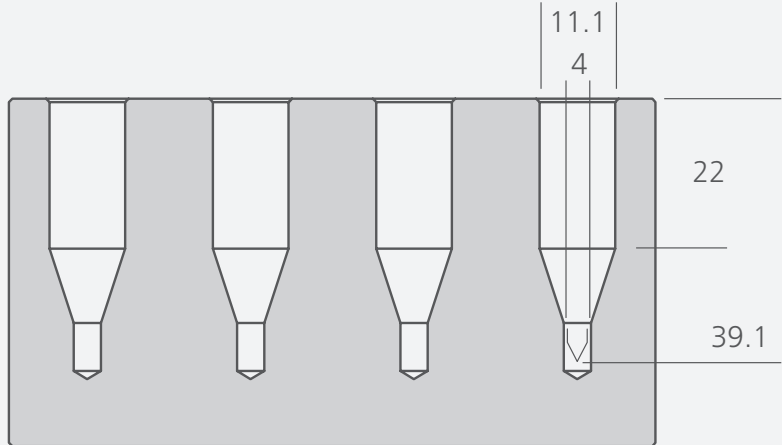

C-C (1:1)

Heating Block DB 3.3

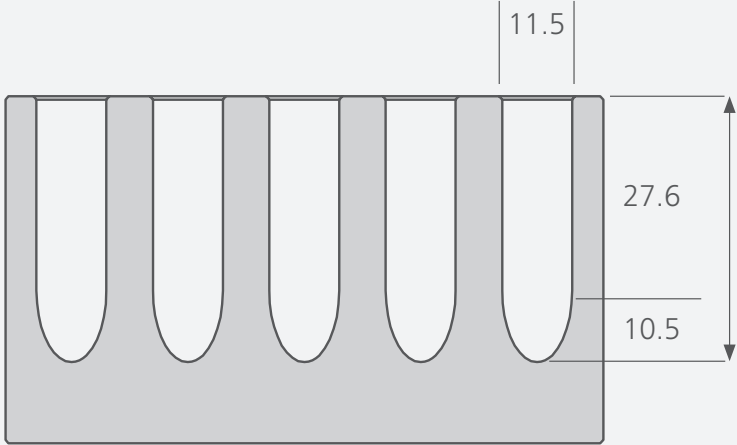
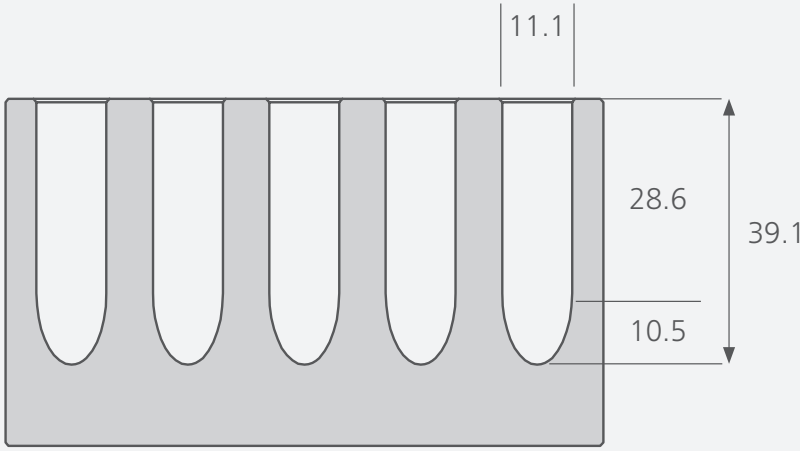
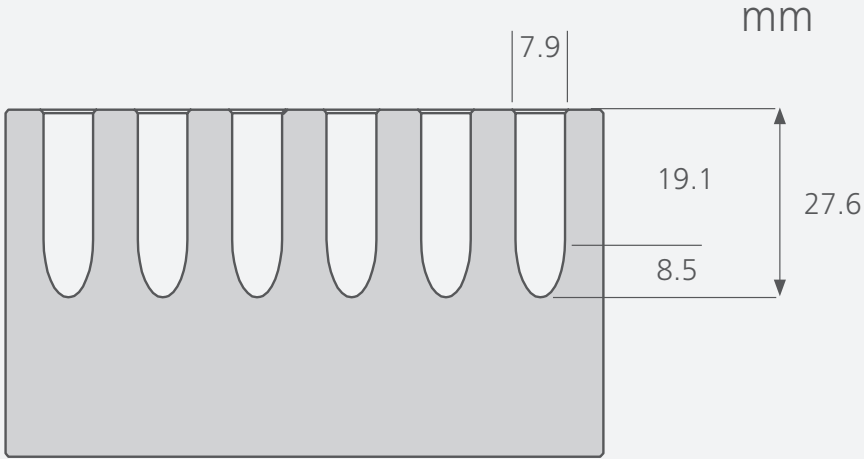
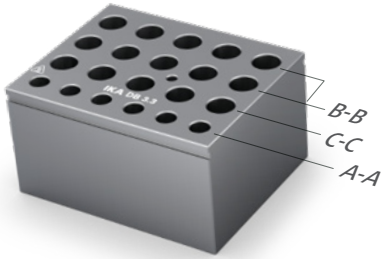

Heating Block DB 4.1



mm

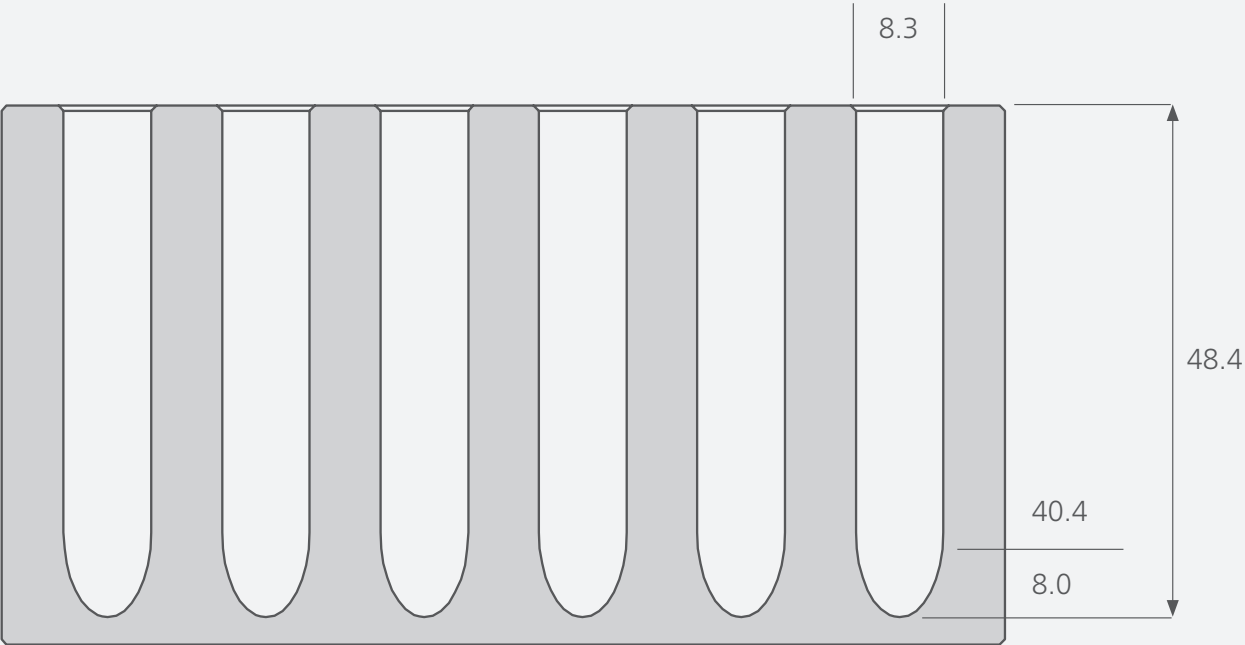

Heating Block DB 4.2



mm

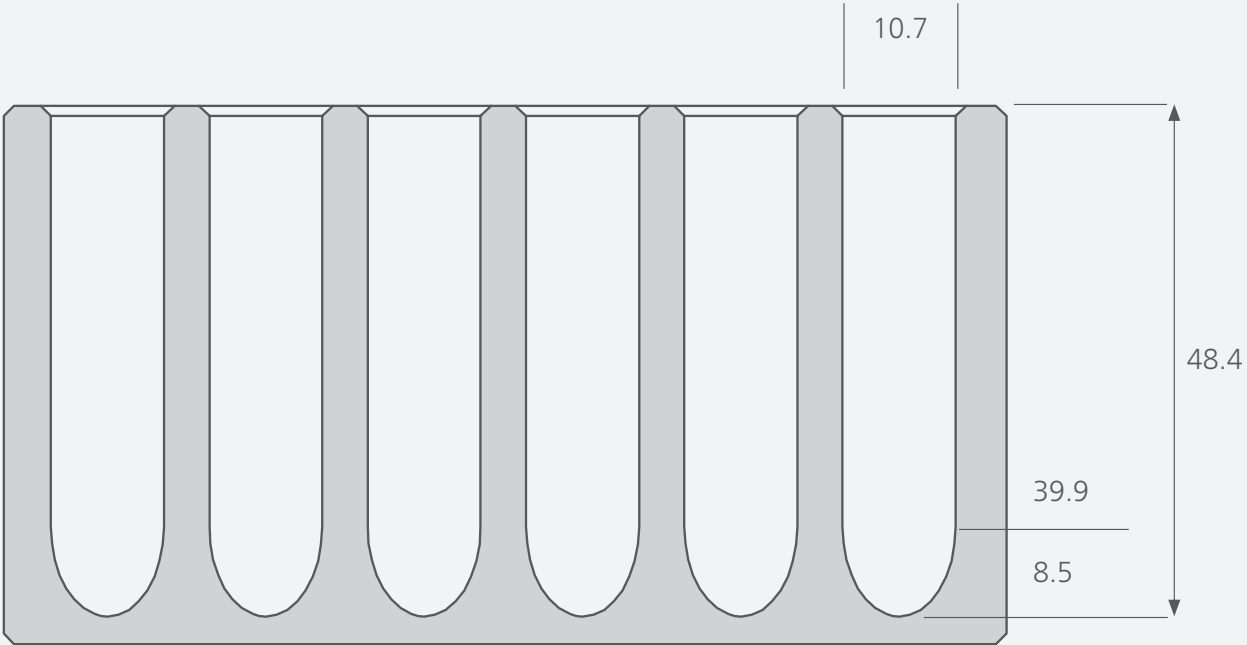

Heating Block DB 4.3



mm

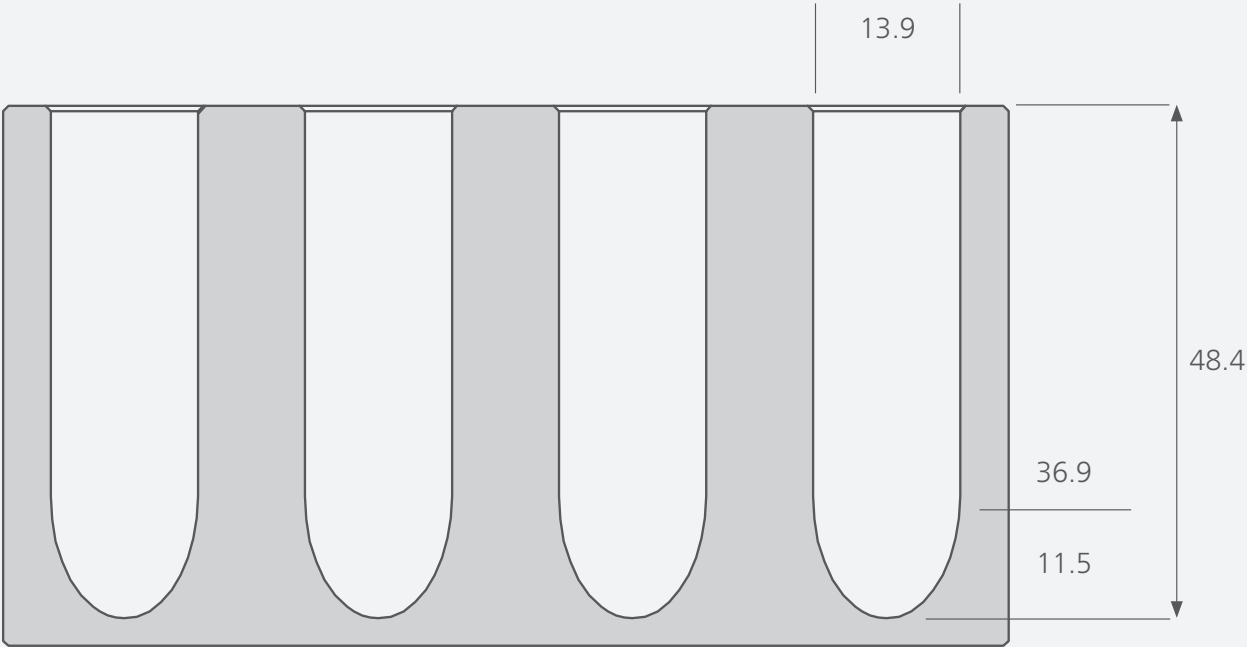

Heating Block DB 4.4

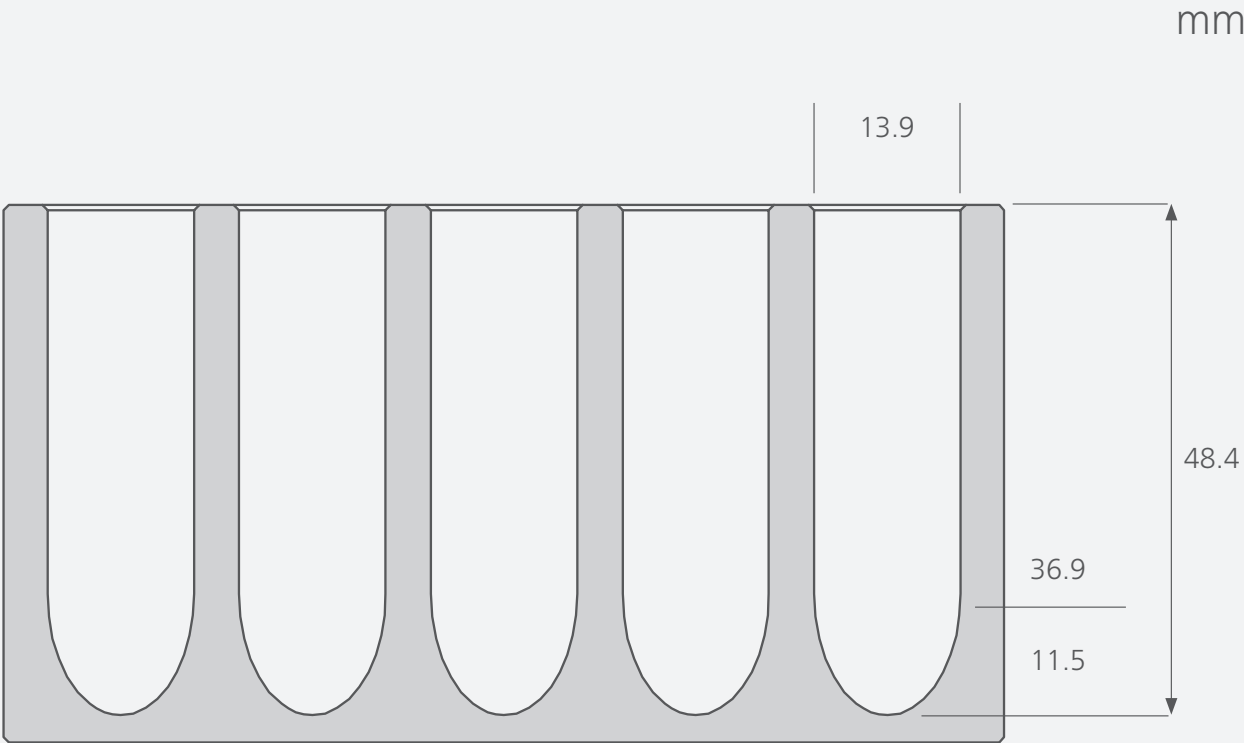

Heating Block DB 4.5

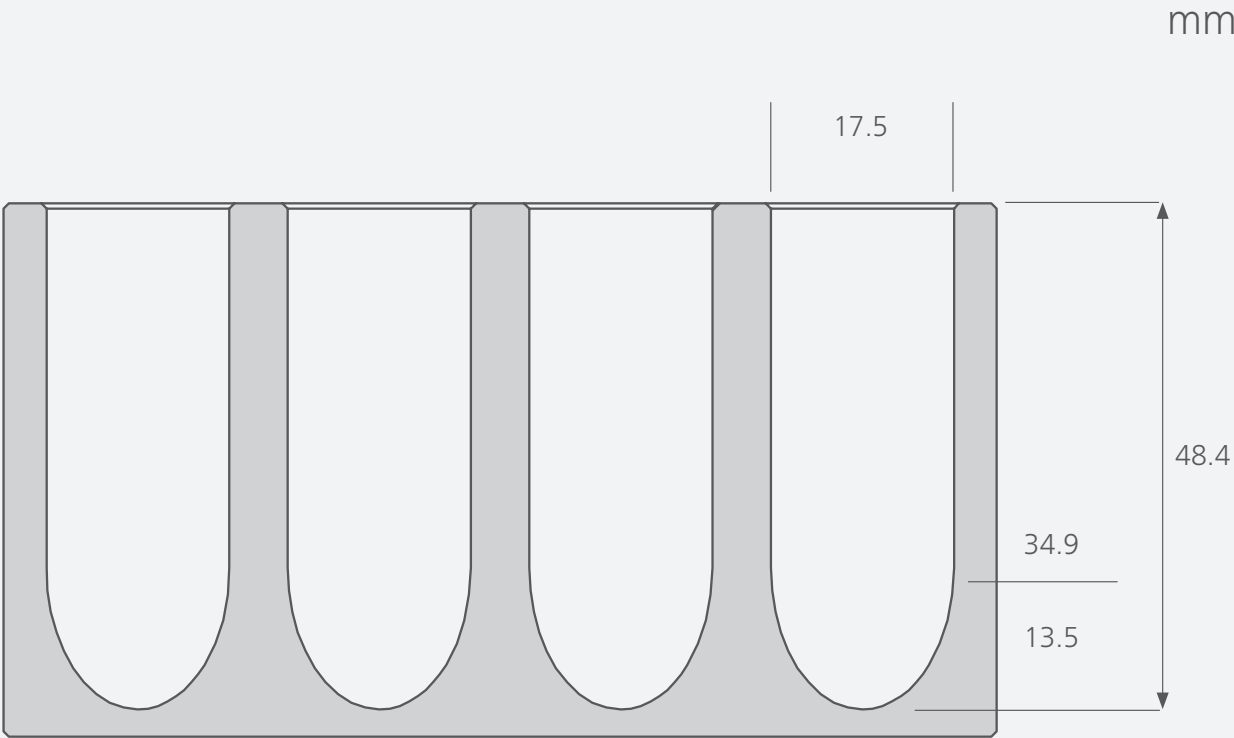

Heating Block DB 4.6

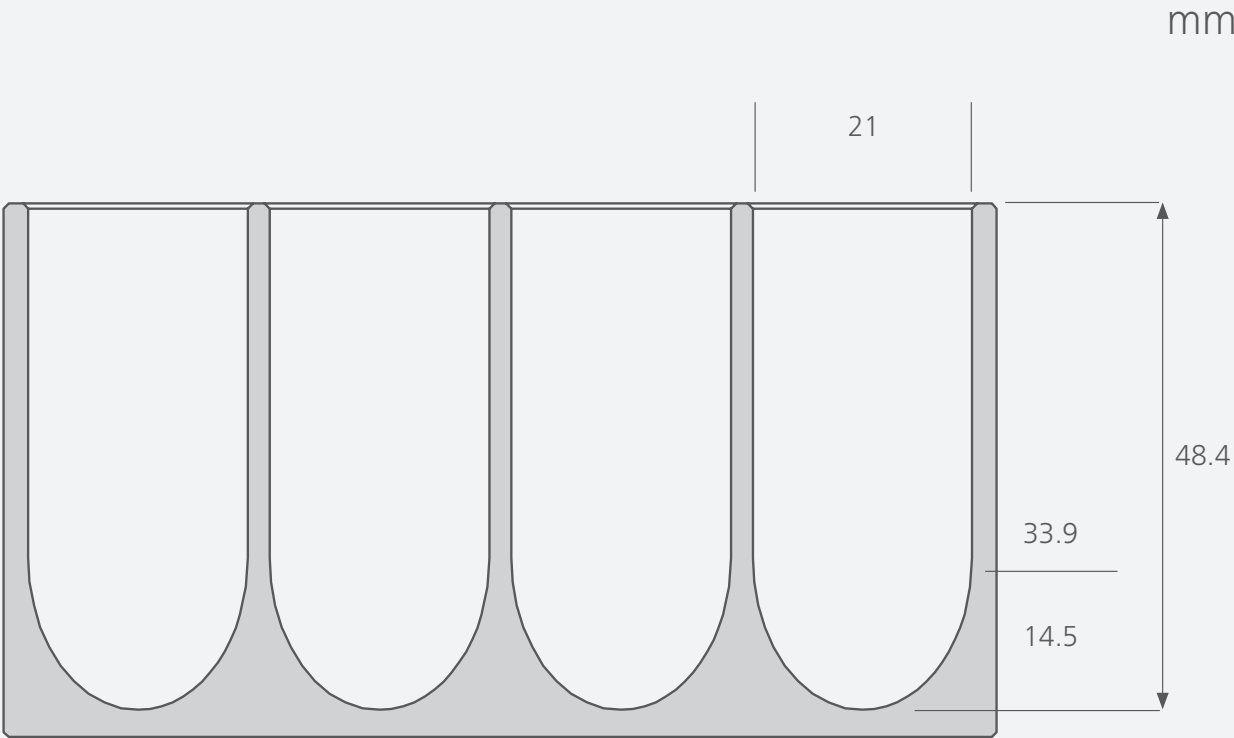

Heating Block DB 4.7

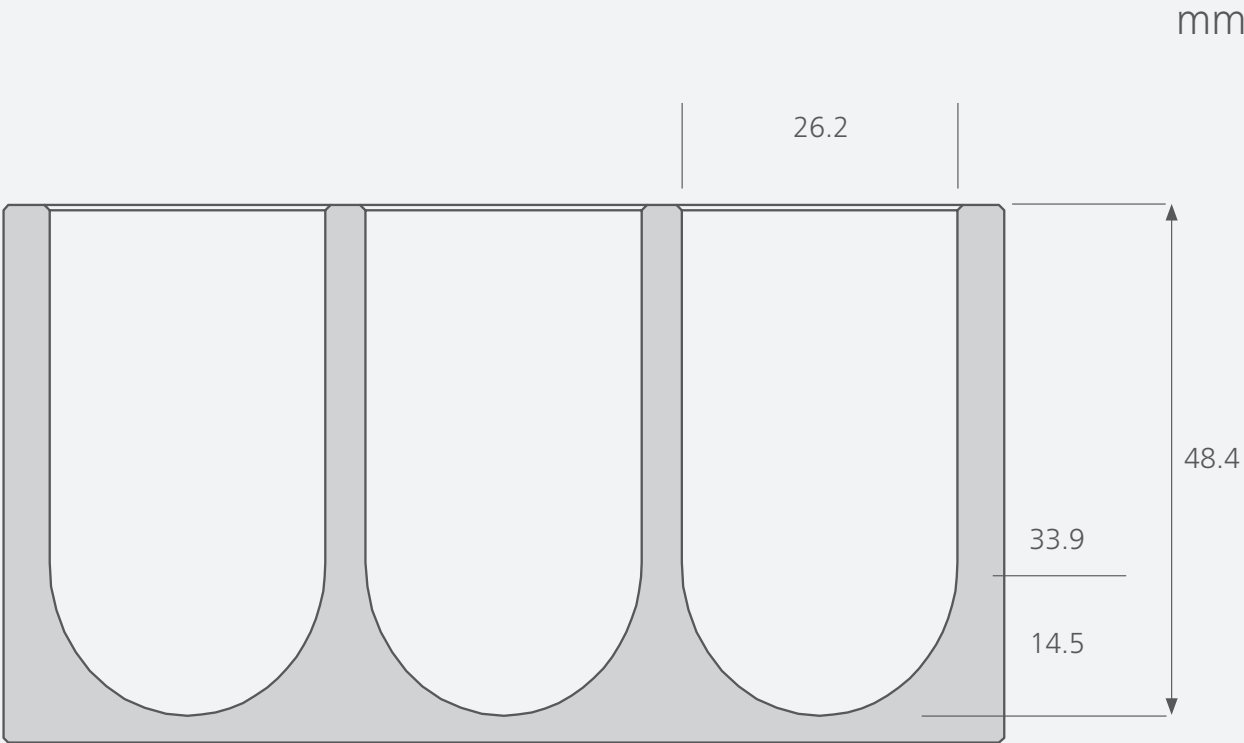

Heating Block DB 4.8

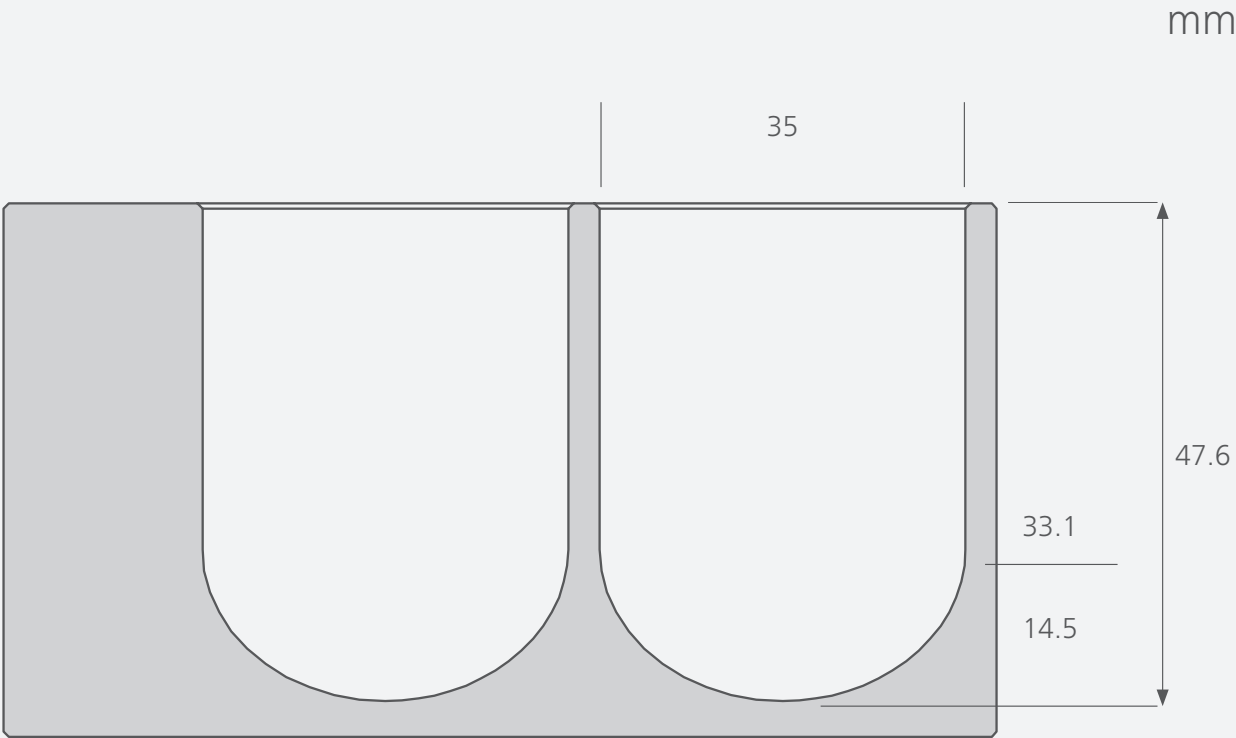

Heating Block DB 4.9



mm

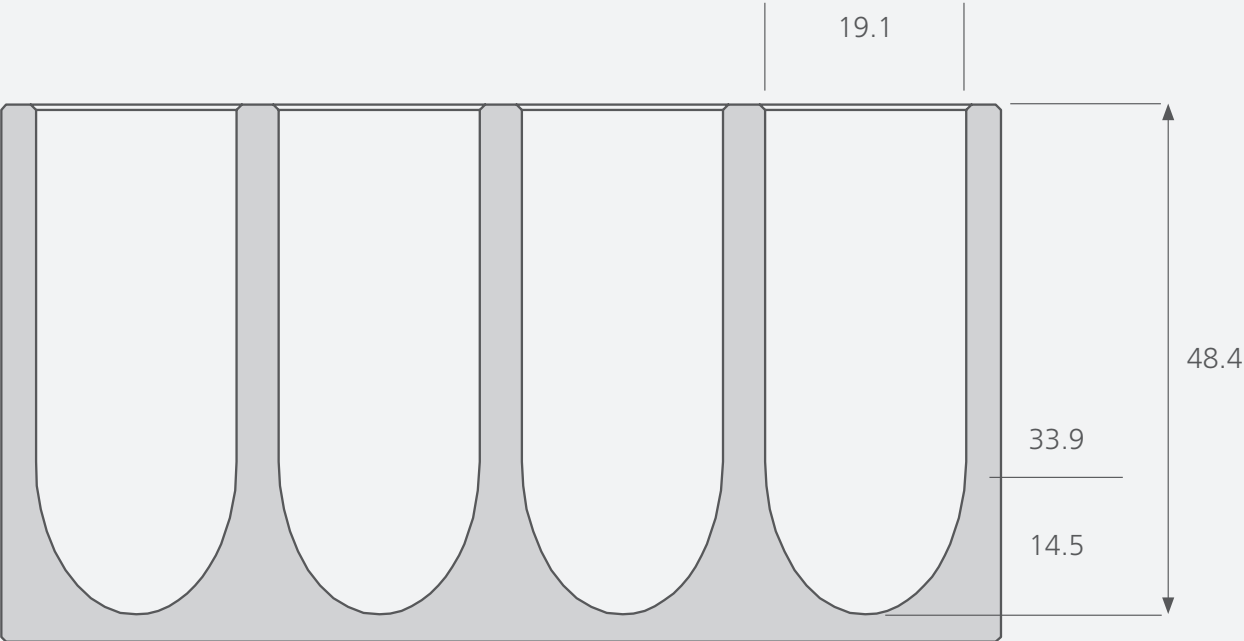

Heating Block DB 5.1



mm



Heating Block DB 5.2



mm

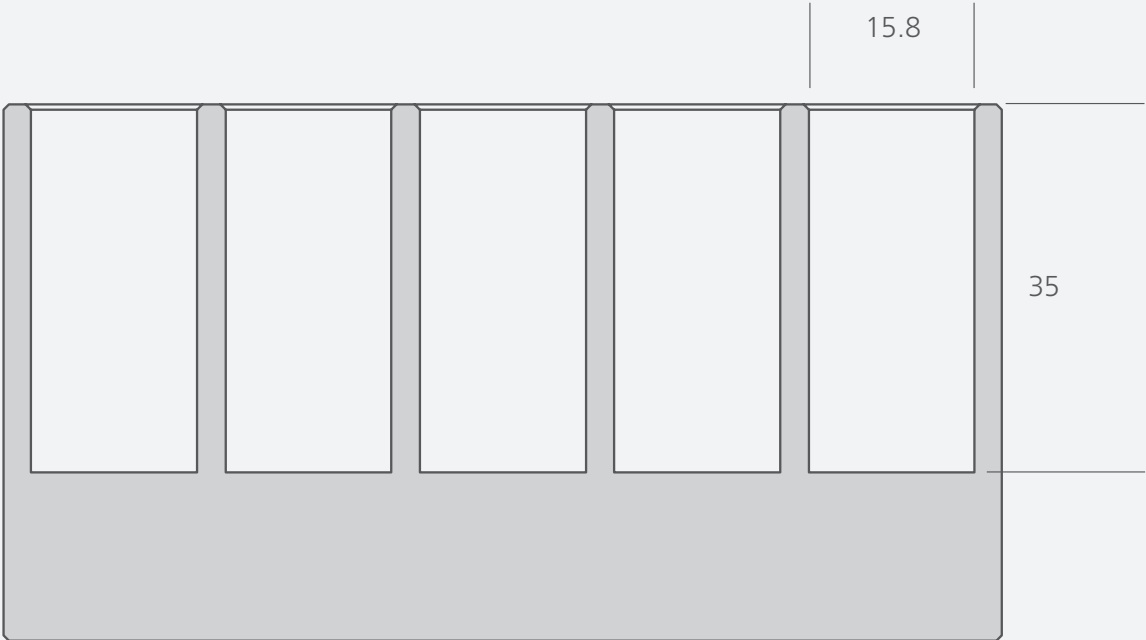

Heating Block DB 5.3



mm



Heating Block DB 5.4



mm



Heating Block DB 5.5



mm

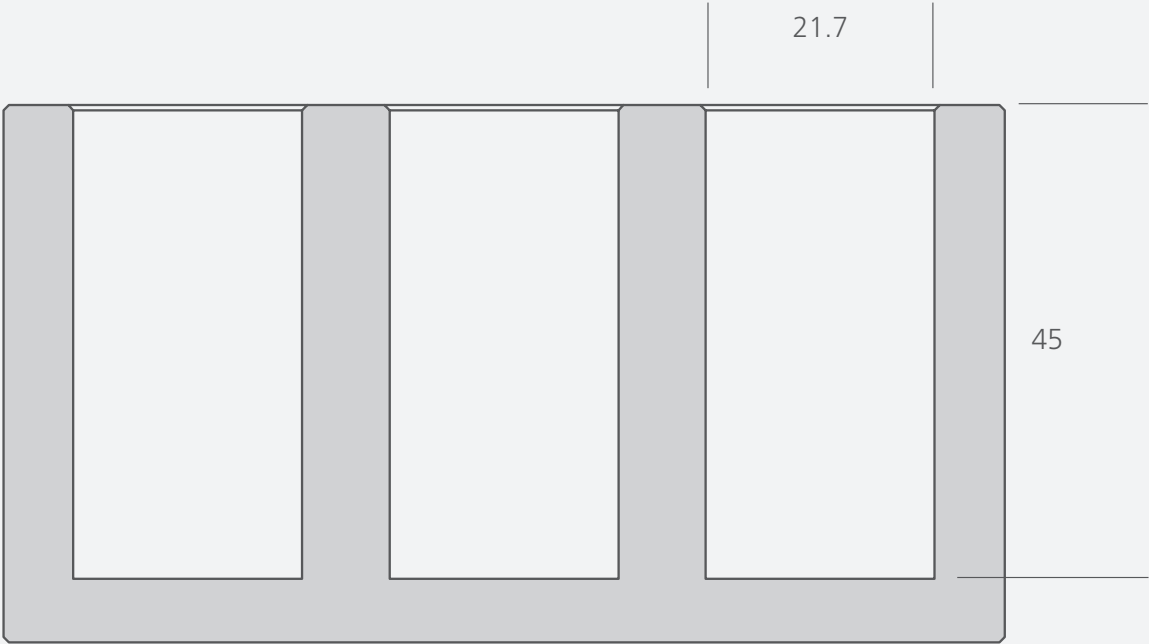

Heating Block DB 5.6



mm



Heating Block DB 5.7



mm

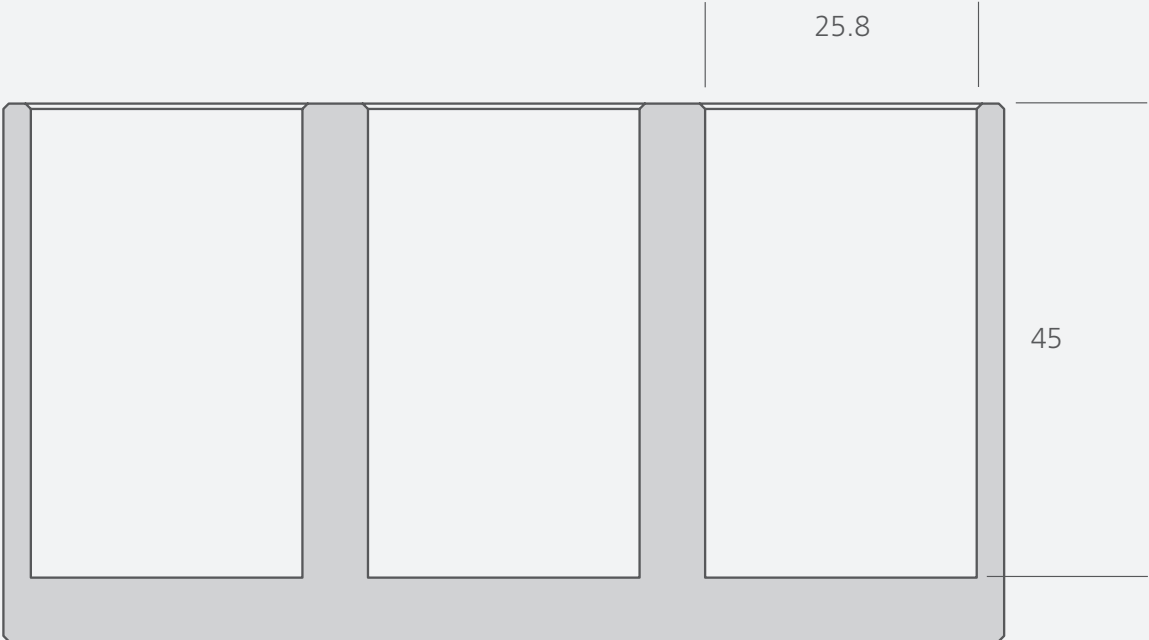

Heating Block DB 5.8



mm



Heating Block DB 5.9



mm



Heating Block DB 6.1



mm



Heating Block DB 6.2



mm

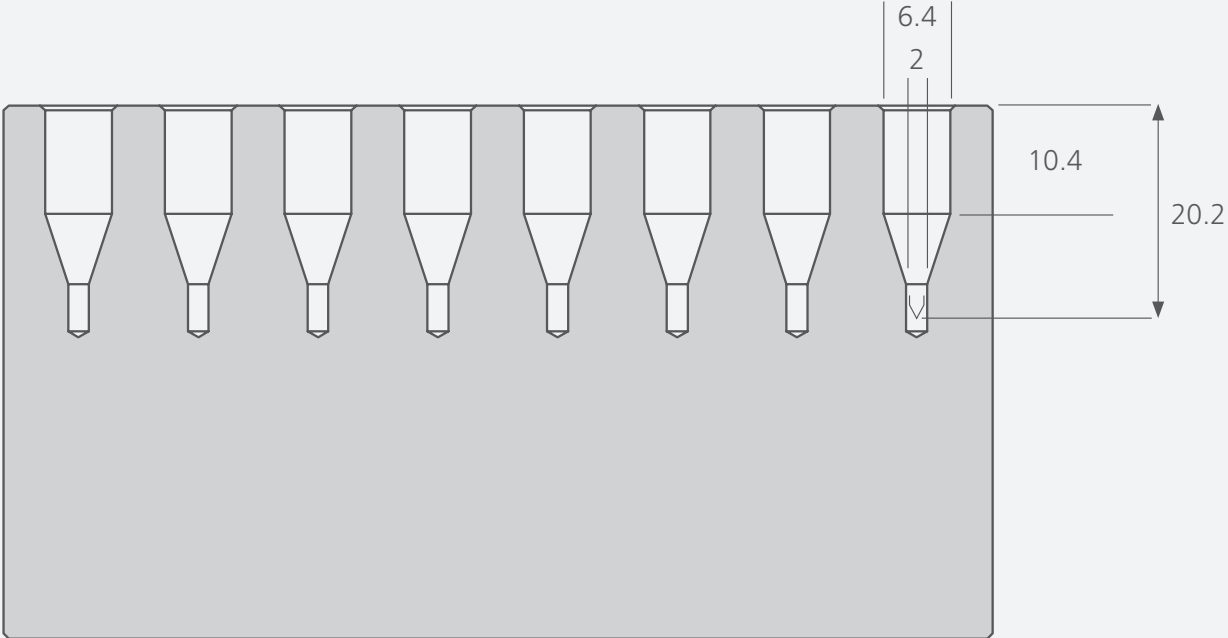

Heating Block DB 6.3



Heating Block DB 7.1



mm

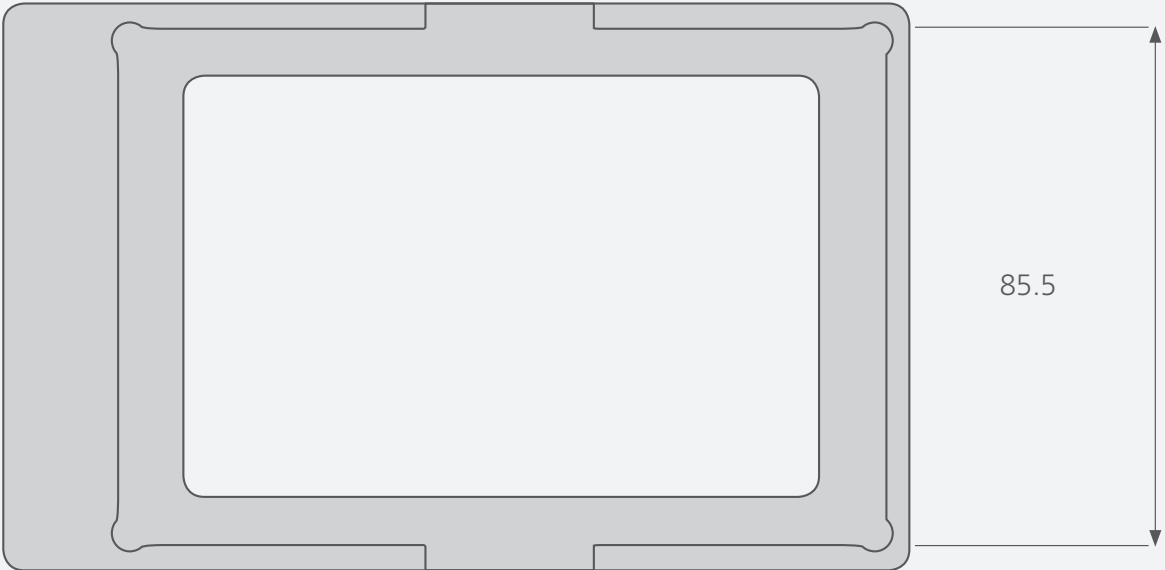
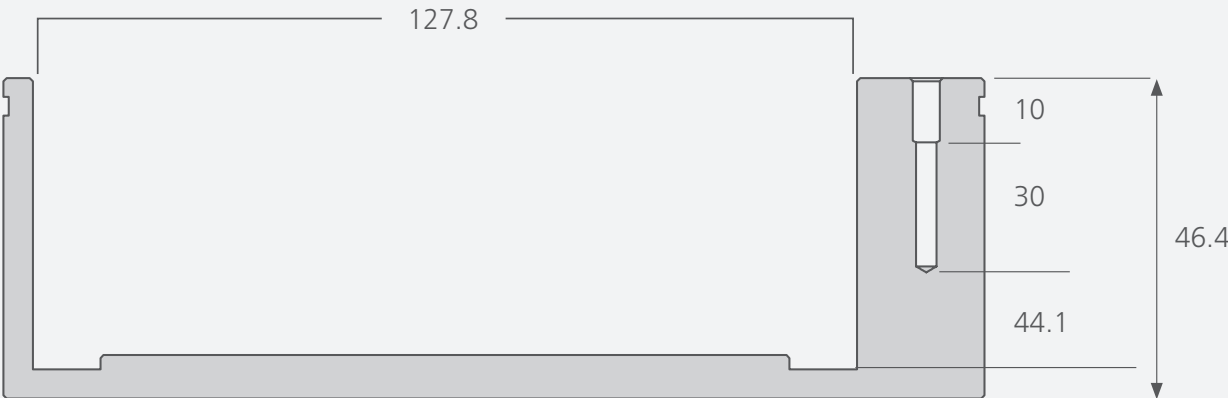

A-A (1:1) top view

Heating Block DB 8.1



mm

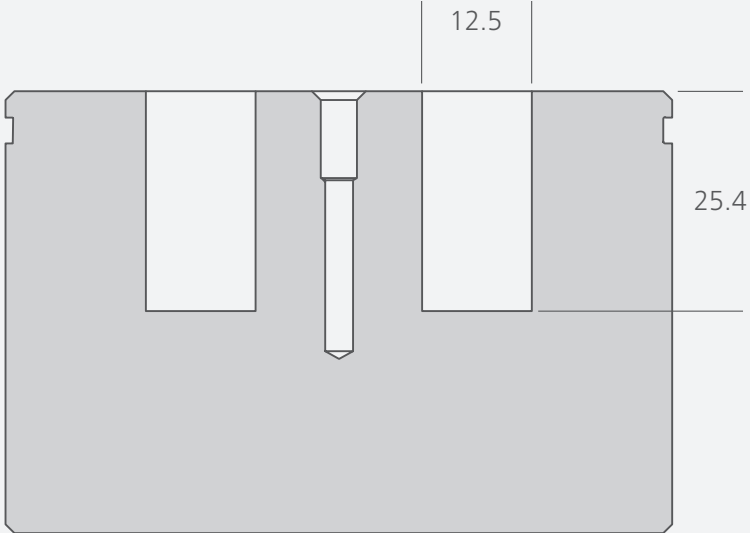

A-A (1:1)

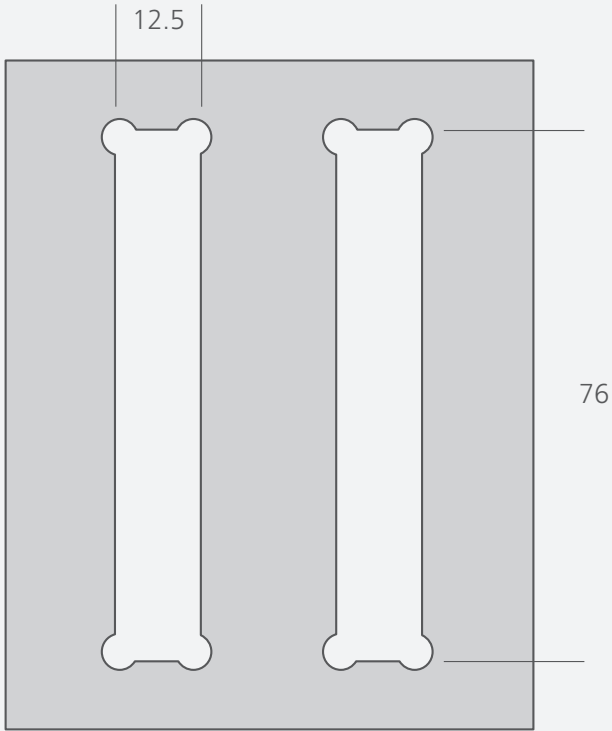

A-A (1:1) top view

Dry Block Heater for a broad range of applications



Dry Block Heater

Digital block heater for one to four aluminum blocks provides precise temperature control in small vessels. Included PT-1000 temperature sensor allows temperature control directly in the sample vessel. It is used with PCR tubes, PCR strips, Greiner tubes, microplates and cuvettes. The block heater is ideal for melting and boiling point determination, enzyme reactions, incubation and activation of cultures, immunoassays, DNA denaturation, culture media test, coagulation test, blood-urea-nitrogen determination and in situ hybridizations.



Dry Block Heater 1
Ident. No. 0004025100

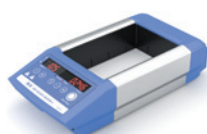

Dry Block Heater 2
Ident. No. 0004025200

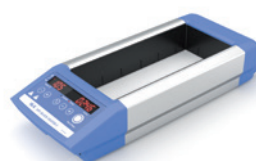

Dry Block Heater 3
Ident. No. 0004025300

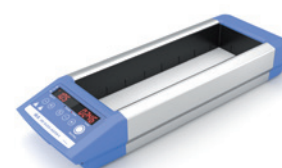

Dry Block Heater 4
Ident. No. 0004025400

000 «Диаэм»

Москва
ул. Магаданская, д. 7, к. 3 ■ тел./факс: (495) 745-0508 ■ sales@dia-m.ru

www.dia-m.ru

С.-Петербург
+7 (812) 372-6040
spb@dia-m.ru

Новосибирск
+7(383) 328-0048
nsk@dia-m.ru

Воронеж
+7 (473) 232-4412
vrn@dia-m.ru

Йошкар-Ола
+7 (927) 880-3676
nba@dia-m.ru

Красноярск
+7(923) 303-0152
krsk@dia-m.ru

Казань
+7(843) 210-2080
kazan@dia-m.ru

Ростов-на-Дону
+7 (863) 303-5500
rnd@dia-m.ru

Екатеринбург
+7 (912) 658-7606
ekb@dia-m.ru

Кемерово
+7 (923) 158-6753
kemerovo@dia-m.ru

Армения
+7 (094) 01-0173
armenia@dia-m.ru

