

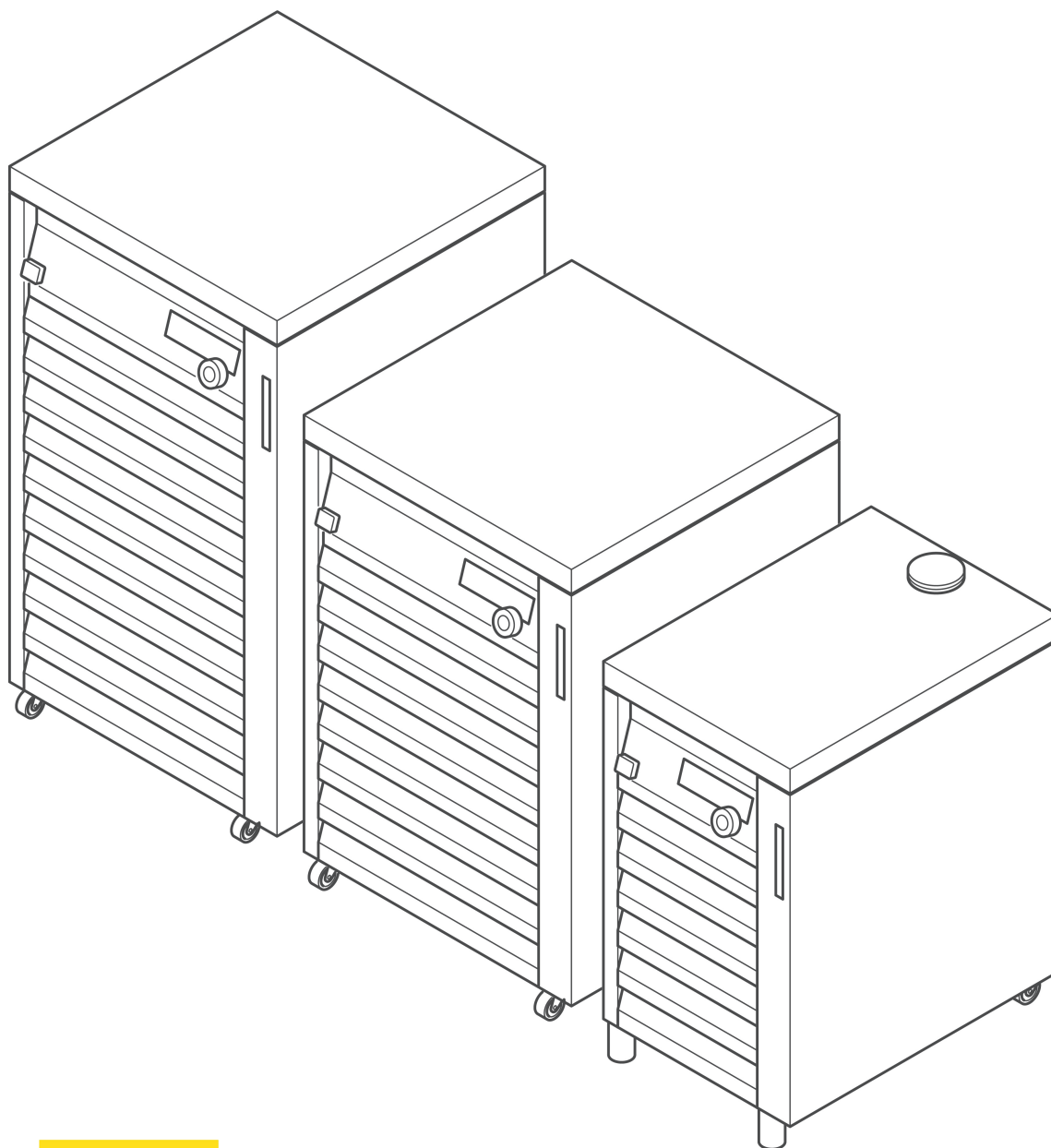

## Recirculating Chiller F-305, F-308, F-314

### Technical data sheet

The BUCHI recirculating chillers are meant to be used with laboratory equipment that requires coolant flow such as rotary evaporators, parallel evaporators, Kjeldahl- and extraction products. The F-300 line is specifically designed for seamless integration into a BUCHI Rotavapor® R-300 system. The temperature can conveniently be set by the interface. Furthermore, it offers ECO-mode, temperature lock and instant start with dynamic pressure adjustment without waiting until the chiller reaches its set temperature.



## Overview

The Recirculating Chiller F-305 / F-308 / F-314 cover a temperature range of -10 to + 25 °C. The chillers differ in the cooling capacity to support various laboratory instruments.

Recommended chiller when working at 15 °C cooling and 20 °C ambient temperature

	F-305	F-308	F-314
Cooling capacity at 15 °C	550 W	900 W	1400 W
Supported lab-size rotary evaporator	1	2	3 – 4
Supported parallel evaporator	-	1	2
Supported extraction system	-	1	2
Supported Kjeldahl products	-	1 stand-alone	1 sampler system

## Recommended chiller when working at other cooling temperatures

The following graph shows the relation between cooling capacity and temperature at 25 °C ambient conditions; the lower the temperature, the lower the cooling capacity. In addition to the ambient temperature, the cooling capacity is influenced by humidity, tubing length, tubing diameter, etc.

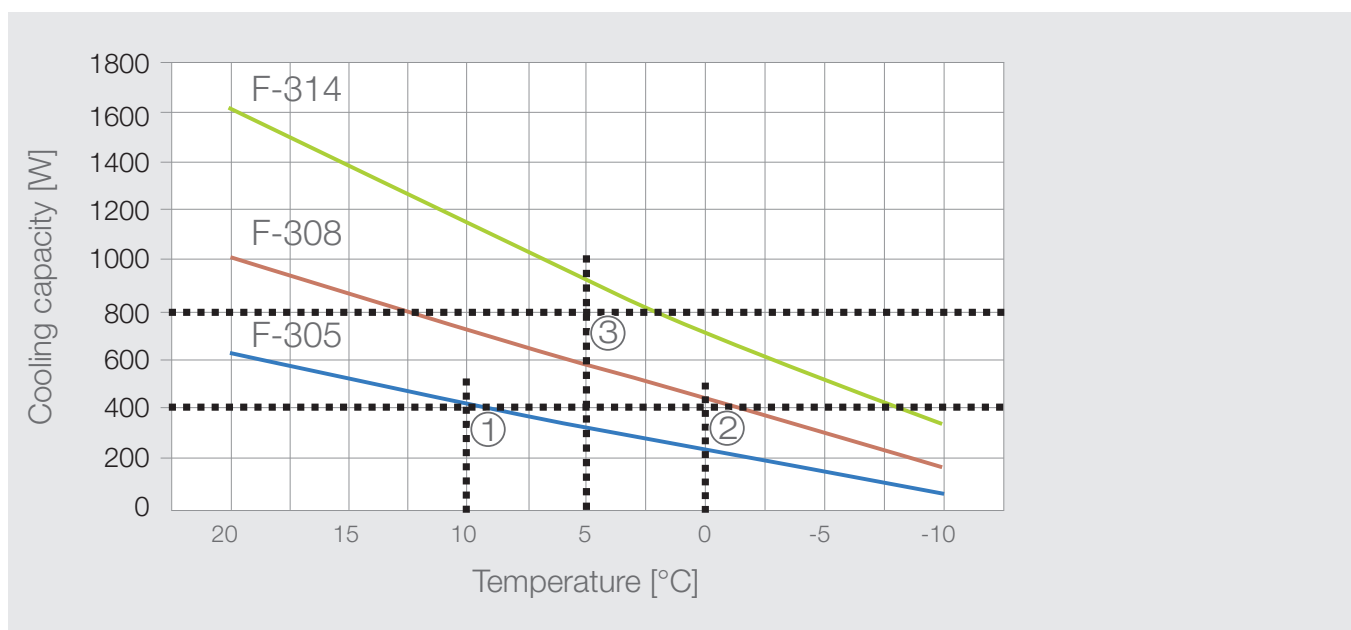

Typically required cooling capacity for laboratory instruments:

Rotary evaporator:	400 W
Extraction units:	550 W
Kjeldahl unit:	700 W
Parallel evaporation:	600 W

## Examples:

- ① Distillation with one rotary evaporator at 10 °C      F-305
- ② Distillation with one rotary evaporator at 0 °C      F-308
- ③ Distillation with two rotary evaporators at 5 °C      F-314

## Order code

Choose the configuration according to your needs:

**1 1 F 3**     **0**  

Recirculating Chiller Type

- 05 F-305 (550 W at 15 °C)
- 08 F-308 (900 W at 15 °C)
- 14 F-314 (1400 W at 15 °C)

Voltage

- 1 230 V
- 2 115 V

## Scope of delivery

All configurations are supplied ready to use.

	F-305	F-308	F-314
Hose clamp	4	4	4
Power cord	1	1	1
Control cable, 2 m	1	1	1
Hose barb, Ø 8 mm	2	2	-
Hose barb, Ø 9.5 mm	-	2	2
Hose barb, Ø 13.5 mm	-	-	2

## Technical data

### Recirculating Chiller

	F-305	F-308	F-314
Dimensions (W x D x H)	280x 500 x 400mm	400 x 500 x 580 mm	400 x 500 x 660 mm
Weight	31 kg	41 kg	52 kg
Cooling capacity at 15 °C*	550 W	900 W	1400 W
Cooling capacity at 10 °C*	440 W	730 W	1150 W
Cooling capacity at 0 °C*	250 W	450 W	720 W
Cooling capacity at -10 °C*	80 W	180 W	350 W
Temperature range	-10 to +25 °C	-10 to +25 °C	-10 to +25 °C
Heating emission	750 W	1400 W	2100 W
Power consumption	800 W	1100 W	1500 W
Voltage	230 V AC ± 10 % 115 V AC ± 10 %	230 V AC ± 10 % 115 V AC ± 10 %	230 V AC ± 10 % 115 V AC ± 10 %
Frequency at 230 V	50 - 60 Hz	50 - 60 Hz	50 - 60 Hz
at 115 V	60 Hz	60 Hz	60 Hz
Temperature reading resolution	0.1 °C	0.1 °C	0.1 °C
Hysteresis	± 1 °C	± 1 °C	± 1 °C
Refrigerant	R134a	R134a	R134a
Tank capacity	3.0 L	4.5 L	6.5 L
Tubing connector	8 + 9.5 mm	8 + 9.5 mm	9.5 + 13.5 mm
Pump pressure	0.6 bar	0.6 bar	1 bar
Pump delivery rate	2.5 L/min	3 L/min	11 L/min
Overvoltage category	II	II	II
Display	Digital	Digital	Digital

\* Measured at 20°C ambient temperature.

### Compatibility and communication requirements with a F-305 / F-308 / F-314

Interface /	Compatibility / Mode	Communication requirements
Vacuum Controller		
I-300 / I-300 Pro	compatible controlled	VacuBox 2x Communication cable. BUCHI COM 6p: 11058705 (0.3 m), 11058707 (1.8 m), 11058708 (5 m) or 11064090 (15 m) Power is supplied through connection with other appropriate peripherals.
I-100	compatible on/off	Communication cable. Mini-DIN 8p: 11060882 (0.6 m) or 038010 (1.5 m) Power adapter (11060669)
V-850 / V-855*	compatible on/off	Communication cable. Mini-DIN 6p to RJ45 11060649 (1.5 m) or 11064104 (3 m) Power adapter (11060669)

Interface /	Compatibility / Mode	Communication requirements
-------------	----------------------	----------------------------

Vacuum Controller		
-------------------	--	--

V-800 / V-805	-	-
---------------	---	---

\* Vacuum Controller V-850/V-855 only communicates with the Recirculating Chiller F-305/F-308/F-314 when firmware version 3.0 (or newer) is installed.

### Explanation of terms

speed controlled	Recirculating chiller is turned on/off and the temperature can be set via the interface. The actual temperature is displayed on the interface. Additional features when the system is operating in „controlled“ mode are listed as follows.
------------------	---

on/off	Recirculating chiller is automatically turned on/off via the interface.
--------	---

-	Connection not possible.
---	--------------------------

A VacuBox is included when ordering Rotavapor® R-300 with an Interface I-300 or Interface I-300 Pro compatibility pack.

## Recirculating Chiller F-305 / F-308 / F-314 features

The Recirculating Chillers F-305 / F-308 / F-314 offer various features when operating stand-alone or as part of a Rotavapor® R-300 system in conjunction with the Interface I-300 or I-300 Pro.

Feature	Description	With Interface
Firmware update	With the BUCHI Monitor App and BUCHI Bluetooth Dongle, firmware updates can easily be done by the user at no costs.	
Temperature setting on chiller	Set the temperature in 0.1 °C increments using the navigation knob. Actual and set temperatures are shown on the integrated display.	
Temperature lock	Lock the set temperature with a push of the navigation knob to avoid unintentional changes.	
Remote control with interface	In addition to the setting of the chiller, the temperature can conveniently be set on the central interface thus showing all process parameters at a glance.	•
Remote monitoring	The BUCHI Monitor App for PCs and mobile devices offers live views and graphical displays of process parameters, as well as push notifications when an action is required, to drastically reduce the hands-on time at the instrument and free valuable time for other tasks.	•
Dynamic operation	The distillation process can be started instantly when using the solvent library mode. While the chiller reaches its set temperature, the vacuum is dynamically adjusted.	•
Automatic stop	The chiller can be configured to stop automatically when the distillation process is terminated.	•
ECO-mode	Alternatively to the automatic stop the ECO-mode switches the chiller into a stand-by mode when not in use. The temperature increases by a definable $\Delta T$ to be cooled down to the set temperature periodically (see graph below).	•

### Eco-mode

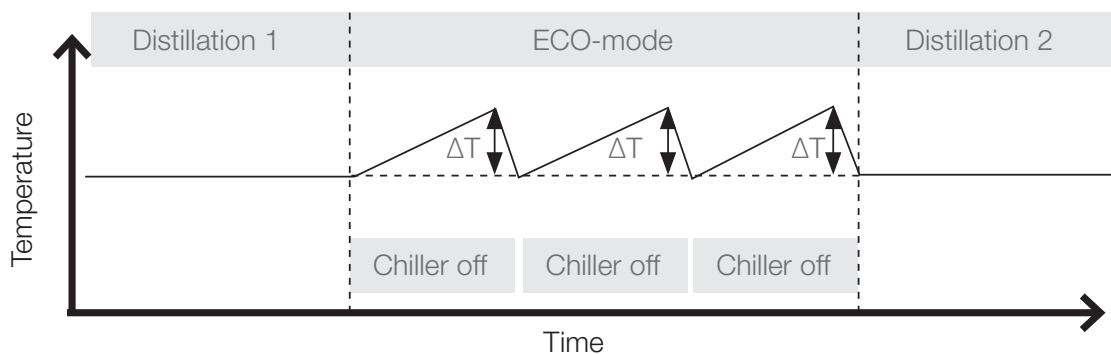

## Feature comparison ( F-305 / F-308 / F-314 and Interface)

Features	I-300 Pro / I-300	I-100	V-850 / V-855	V-800 / V-805	Without interface
Power saving mode	•				•*
Automatic stop	•		•		
Dynamic distillation (only when connected to Rotavapor® R-300 and vacuum pump)	•				
Remote monitoring	•				

## All recirculating chillers at a glance

The BUCHI recirculating chiller portfolio is completed with the F-100 line. The following table provides an overview of the different features.



F-100  
300 W / 10 °C



F-105  
530 W / 15 °C



F-305  
550 W / 15 °C

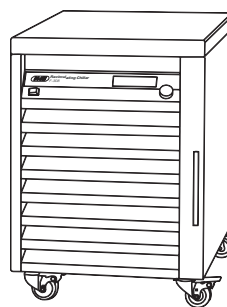

F-308  
900 W / 15 °C

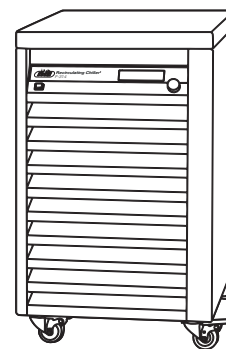



F-314  
1400 W / 15 °C

	F-100	F-105	F-305	F-308	F-314
Cooling capacity at 15 °C	400 W	530 W	550 W	900 W	1400 W
Temperature range	Fix at 10 °C	-10 °C to +25 °C	-10 °C to +25 °C	-10 °C to +25 °C	-10 °C to +25 °C
Eco mode to save energy	-	-	•	•	•
Temperature lock	-	-	•	•	•
Recommended BUCHI Rotavapor® line	Rotavapor® R-100	Rotavapor® R-100	Rotavapor® R-300	Two Rotavapor® R-300	Two Rotavapor® R-300
ON/OFF control via interface on recom. Rotavapor®	-	•	•	•	•
Temperature setting via interface on recom. Rotavapor®	-	-	•	•	•
Other applications	Small distillation apparatus	Small distillation apparatus	Small distillation apparatus	Kjeldahl Extraction Parallel evaporator	Parallel evaporator at low temperature Kjeldahl systems

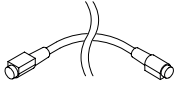
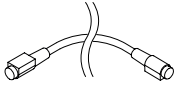

## Spare parts and accessories

### Communication cable

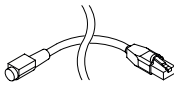
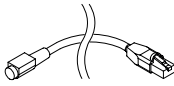
	Order no.	Image
Communication cable. BUCHI COM, 1.8 m, 6p Enables connection between Rotavapor® R-300 / R-220 Pro, Interface I-300 / I-300 Pro, Vacuum Pump V-300 / V-600, Recirculating Chiller F-3xx, VacuBox and LegacyBox.	11058707	
Communication cable. BUCHI COM, 5.0 m, 6p Enables connection between Rotavapor® R-300 / R-220 Pro, Interface I-300 / I-300 Pro, Vacuum Pump V-300 / V-600, Recirculating Chiller F-3xx, VacuBox and LegacyBox.	11058708	
Communication cable. BUCHI COM, 15 m, 6p Enables connection between Rotavapor® R-300 / R-220 Pro, Interface I-300 / I-300 Pro, Vacuum Pump V-300 / V-600, Recirculating Chiller F-3xx, VacuBox and LegacyBox.	11064090	
Communication cable. Mini-DIN 6p to RJ45, 1.5 m Connection between Vacuum Controller V-850 / V-855 and Vacuum Pump V-300 / V-600 or between Vacuum Controller V-850 / V-855, Interface I-100 and Recirculating Chiller F-305 / F-308 / F-314.	11060649	
Communication cable. Mini-DIN 6p to RJ45, 3 m Connection between Vacuum Controller V-850 / V-855 and Vacuum Pump V-300 / V-600 or between Vacuum Controller V-850 / V-855, Interface I-100 and Recirculating Chiller F-305 / F-308 / F-314.	11064104	

### Tubing

	Order no.
Tubing. Nylflex, PVC-P, Ø8/14 mm, transparent, per m	004113

### Insulation

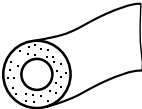
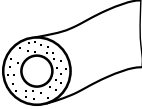
	Order no.	Image
Hose insulation, Kaiflex, 11/23 mm, 1 m, black	028696	
Hose insulation, Kaiflex, 16/27 mm, 1 m, black	11056888	

## Further accessories

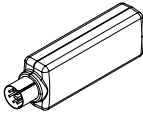
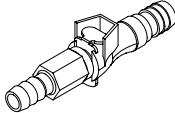
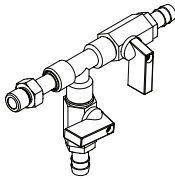
	Order no.	Image
<p>BUCHI Bluetooth® Dongle, connects instrument to smartphone via Bluetooth®</p> <p>Needed for firmware updates and eSupport.</p>	11067770	
<p>Coupling, set. Quick-release coupling, 8 mm, set of 2</p> <p>Use: connection of two cooling tubes together.</p>	042885	
<p>Distribution piece. T-piece incl. shut off valve, hose barb Ø 9 mm</p> <p>Use: to connect two peripherals with one recirculating chiller</p>	037742	

## Spare parts

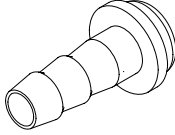
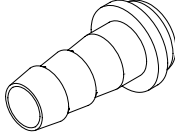
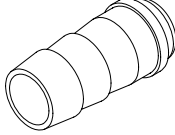
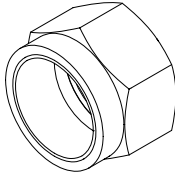
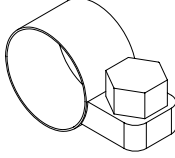
	Order no.	Image
Hose barb, 8 mm	11062530	
Hose barb, 9.5 mm	046792	
Hose barb, 13.5 mm	040329	
Union nut, M16x1, Rf, for hose barbs	019889	
Hose clip, 8-16 mm	022352	

	Order no.	Image
Y-connector, PP, 8 mm	011043	
Y-connector, PP, 12 mm	11058358	

## Power cords

	Order no.
Power cord, 3-pin, type CH	010010
Power cord, 3-pin, type DE	010016
Power cord, 3-pin, type GB	017835
Power cord, 3-pin, type AU	017836
Power cord, 3-pin, type US	010020
Power cord, 3-pin, type US for F-314	11061527
Power cord, 3-pin, type IND	11060536
Power cord, 3-pin, type JP	11061564

**000 «Диаэм»**

Москва  
ул. Магаданская, д. 7, к. 3 ■ тел./факс: (495) 745-0508 ■ sales@dia-m.ru

[www.dia-m.ru](http://www.dia-m.ru)

**С.-Петербург**  
+7 (812) 372-6040  
spb@dia-m.ru

**Новосибирск**  
+7 (383) 328-0048  
nsk@dia-m.ru

**Воронеж**  
+7 (473) 232-4412  
vrn@dia-m.ru

**Йошкар-Ола**  
+7 (927) 880-3676  
nba@dia-m.ru

**Красноярск**  
+7 (923) 303-0152  
krsk@dia-m.ru

**Казань**  
+7 (843) 210-2080  
kazan@dia-m.ru

**Ростов-на-Дону**  
+7 (863) 303-5500  
rnd@dia-m.ru

**Екатеринбург**  
+7 (912) 658-7606  
ekb@dia-m.ru

**Кемерово**  
+7 (923) 158-6753  
kemerovo@dia-m.ru

**Армения**  
+7 (094) 01-0173  
armenia@dia-m.ru

